

Varenummer: 2310431073
Beskrivelse: E+G Stilleben
LX.30-SW17-M10X41

Mål

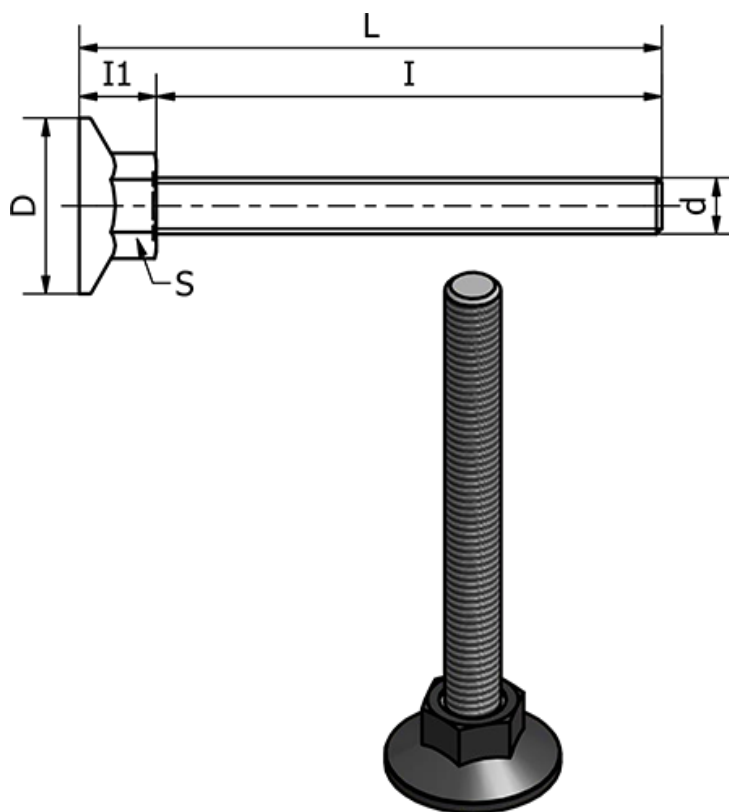

d	= M10
D	= 30
I	= 41
I1	= 12
L	= 53
Max statisk belastning (N)	= 3000
S	= 17
Type	= Forzinket

Vægt (g) = -